

1 CAP STYLE: O57 - 7 PANEL

QUANTITY COLORWAY 1 : _____

QUANTITY COLORWAY 2 : _____

QUICKTURN
96 PC. MINIMUM
48 PC. PER COLORWAY

STANDARD
288 PC. MINIMUM
72 PC. PER COLORWAY

2 CAP DETAILS:

COLORWAY 1 : [CLICK HERE FOR AVAILABLE COLOR SWATCHES](#)

COLORWAY 2 :

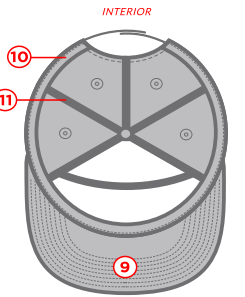
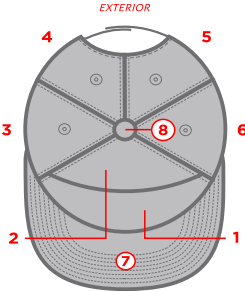

#	COLOR	FABRIC / MATERIAL	STITCH COLOR	EYELET COLOR
1.	_____	_____	_____	_____
2.	_____	_____	_____	_____
3.	_____	_____	_____	_____
4.	_____	_____	_____	_____
5.	_____	_____	_____	_____
6.	_____	_____	_____	_____
7.	_____	_____	_____	_____
8.	_____	_____	_____	_____
9.	_____	_____	_____	_____
10.	_____	_____	_____	_____
11.	_____	_____	_____	_____

#	COLOR	FABRIC / MATERIAL	STITCH COLOR	EYELET COLOR
1.	_____	_____	_____	_____
2.	_____	_____	_____	_____
3.	_____	_____	_____	_____
4.	_____	_____	_____	_____
5.	_____	_____	_____	_____
6.	_____	_____	_____	_____
7.	_____	_____	_____	_____
8.	_____	_____	_____	_____
9.	_____	_____	_____	_____
10.	_____	_____	_____	_____
11.	_____	_____	_____	_____

SUBLIMATION / SCREEN PRINT FILE NAME(S) : _____

METAL EYELETS Y N COLOR: BLACK
 SILVER
 BRASS

ADDITIONAL NOTES

3 VISOR

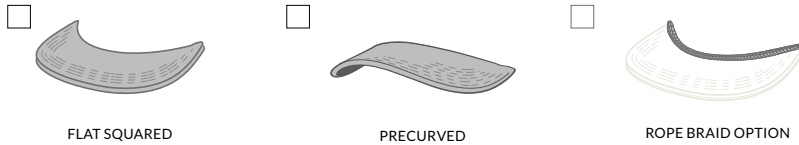

FLAT SQUARED

PRECURVED

ROPE BRAID OPTION

COLOR : _____ / _____

ADDITIONAL NOTES

4 CLOSURE

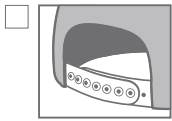

SNAPBACK

COLORWAY 1 / COLORWAY 2

COLOR : _____ / _____

OR



FEMALE SNAP / MALE SNAP

FEMALE SNAP COLOR: _____ / _____

MALE SNAP COLOR: _____ / _____

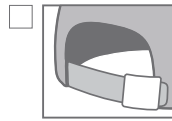

LEATHER STRAPBACK

COLORWAY 1 / COLORWAY 2

LEATHER COLOR

- BLACK
- LIGHT BROWN
- DARK BROWN
- WHITE

METAL CLASP COLOR

- GOLD
- SILVER
- BRONZE
- GUNMETAL BLACK

COLORWAY 2

LEATHER COLOR

- BLACK
- LIGHT BROWN
- DARK BROWN
- WHITE

METAL CLASP COLOR

- GOLD
- SILVER
- BRONZE
- GUNMETAL BLACK

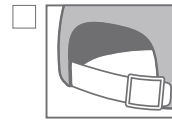

CLOTH HIDEAWAY

COLORWAY 1 / COLORWAY 2

METAL CLASP COLOR

- GOLD
- SILVER
- BRONZE
- GUNMETAL BLACK

COLORWAY 2

METAL CLASP COLOR

- GOLD
- SILVER
- BRONZE
- GUNMETAL BLACK

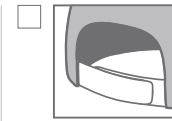

VELCRO

COLOR :

COLORWAY 1 / COLORWAY 2

_____ / _____

OR

LEFT COLOR:

_____ / _____

RIGHT COLOR:

_____ / _____

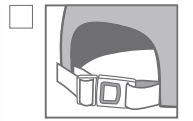

NYLON STRAP W/PLASTIC CLASP

[BLACK ONLY]

5 DECORATION DESIGN MAP :

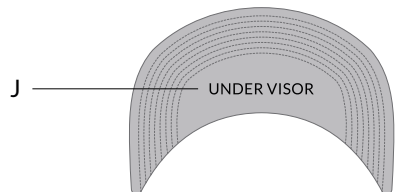
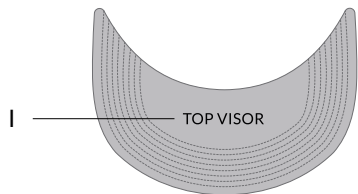
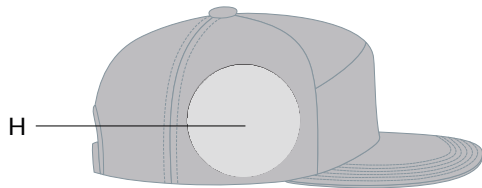
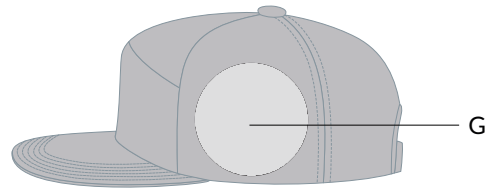
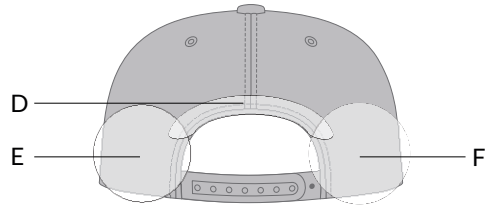
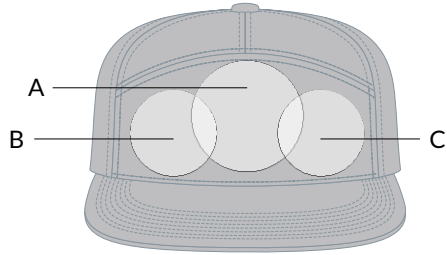

DECORATION 1

LOCATION _____
(LETTER)

FILE NAME _____
(ATTACH WEEMAIL)

SIZE (W x H) _____

COLOR(S) **COLORWAY 1 :** _____
COLORWAY 2 : _____

- | | |
|---|---|
| <input type="checkbox"/> EMBROIDERY | <input type="checkbox"/> WOVEN LABEL |
| <input type="checkbox"/> 3D EMBROIDERY | <input type="checkbox"/> WOVEN PATCH |
| <input type="checkbox"/> FELT APPLIQUE | <input type="checkbox"/> DEBOSSED LEATHER PATCH |
| <input type="checkbox"/> SCREEN PRINT | <input type="checkbox"/> EMBROIDERED PATCH |
| <input type="checkbox"/> TWILL APPLIQUE | <input type="checkbox"/> PRINTED PATCH |

NOTES

DECORATION 2

LOCATION _____
(LETTER)

FILE NAME _____
(ATTACH WEEMAIL)

SIZE (W x H) _____

COLOR(S) **COLORWAY 1 :** _____
COLORWAY 2 : _____

- | | |
|---|---|
| <input type="checkbox"/> EMBROIDERY | <input type="checkbox"/> WOVEN LABEL |
| <input type="checkbox"/> 3D EMBROIDERY | <input type="checkbox"/> WOVEN PATCH |
| <input type="checkbox"/> FELT APPLIQUE | <input type="checkbox"/> DEBOSSED LEATHER PATCH |
| <input type="checkbox"/> SCREEN PRINT | <input type="checkbox"/> EMBROIDERED PATCH |
| <input type="checkbox"/> TWILL APPLIQUE | <input type="checkbox"/> PRINTED PATCH |

NOTES

DECORATION 3

LOCATION _____
(LETTER)

FILE NAME _____
(ATTACH WEEMAIL)

SIZE (W x H) _____

COLOR(S) **COLORWAY 1 :** _____
COLORWAY 2 : _____

- | | |
|---|---|
| <input type="checkbox"/> EMBROIDERY | <input type="checkbox"/> WOVEN LABEL |
| <input type="checkbox"/> 3D EMBROIDERY | <input type="checkbox"/> WOVEN PATCH |
| <input type="checkbox"/> FELT APPLIQUE | <input type="checkbox"/> DEBOSSED LEATHER PATCH |
| <input type="checkbox"/> SCREEN PRINT | <input type="checkbox"/> EMBROIDERED PATCH |
| <input type="checkbox"/> TWILL APPLIQUE | <input type="checkbox"/> PRINTED PATCH |

NOTES

DECORATION 4

LOCATION _____
(LETTER)

FILE NAME _____
(ATTACH WEEMAIL)

SIZE (W x H) _____

COLOR(S) **COLORWAY 1 :** _____
COLORWAY 2 : _____

- | | |
|---|---|
| <input type="checkbox"/> EMBROIDERY | <input type="checkbox"/> WOVEN LABEL |
| <input type="checkbox"/> 3D EMBROIDERY | <input type="checkbox"/> WOVEN PATCH |
| <input type="checkbox"/> FELT APPLIQUE | <input type="checkbox"/> DEBOSSED LEATHER PATCH |
| <input type="checkbox"/> SCREEN PRINT | <input type="checkbox"/> EMBROIDERED PATCH |
| <input type="checkbox"/> TWILL APPLIQUE | <input type="checkbox"/> PRINTED PATCH |

NOTES



6 INTERNAL DECORATION + LABELING

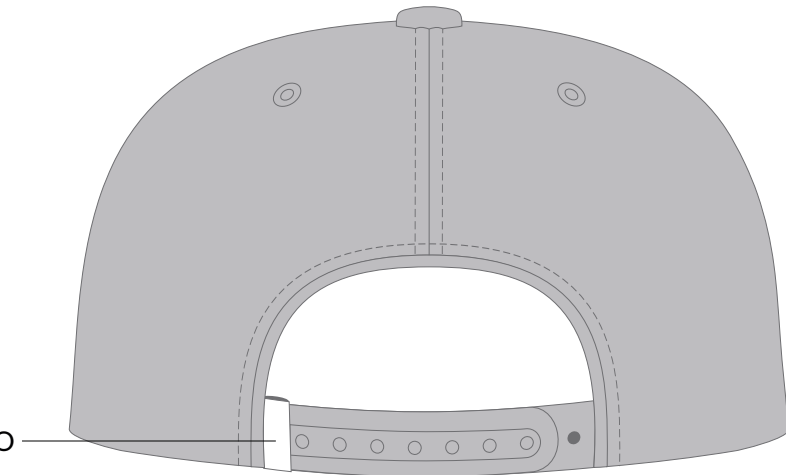
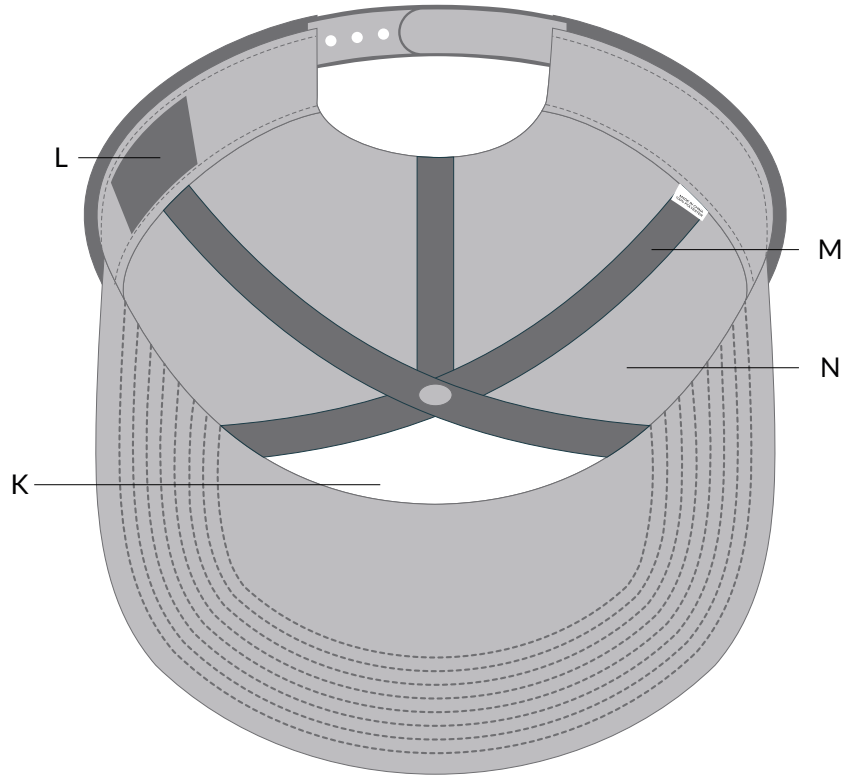

K - CROWN STRUCTURE

- BUCKRAM NO STRUCTURE LIGHT BUCKRAM

L - INTERNAL WOVEN LABEL



PLEASE NOTE: - MAX HEIGHT IS 25mm / .98"
- MAX WIDTH IS 70mm / 2.75"
- LABEL CAN BE PLACED ANYWHERE ON SWEATBAND

LABEL COLOR: _____

FILE NAME: _____
(ATTACH W/EMAIL)

SIZE (W x H): _____

NOTES: _____

M - SEAM TAPE

PLEASE NOTE: - SEAM TAPE IS 13mm TALL / .5" TALL
- HEIGHT BETWEEN STITCHING IS -7mm / -.27" TALL



SEAM TAPE COLOR: _____

FILE NAME: _____
(ATTACH W/EMAIL)

N - INNER LINING

- NONE CVC TWILL TRICOT SATIN

INNER LINING COLOR: _____

SCREEN PRINT YES NO FILE NAME: _____
(ATTACH W/EMAIL)

O - BACKSTRAP WOVEN LABEL



PLEASE NOTE: - MAX HEIGHT IS 20mm / .98"
- RECOMMENDED WIDTH IS 11mm - 15mm / .43"-.6"
- LABEL CAN ONLY BE PLACED ON LEFT SIDE

LABEL COLOR: _____

FILE NAME: _____
(ATTACH W/EMAIL)

SIZE (W x H): _____

ADDITIONAL NOTES / DETAILS FOR CAP

CAP TEMPLATES

ART REQUIREMENTS:

- PLEASE CONVERT TEXT TO OUTLINE
- PLEASE EXPAND ALL STROKES
- APPROPRIATE ART FILE TYPES ARE : AI, EPS, PDF

THIS PAGE IS OPTIONAL

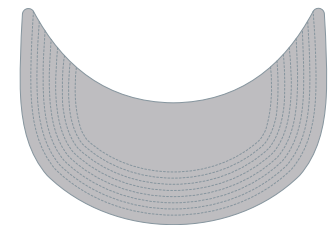
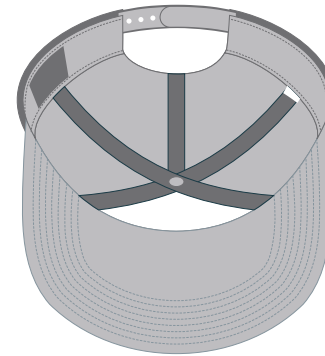
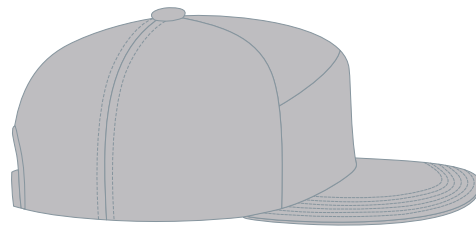
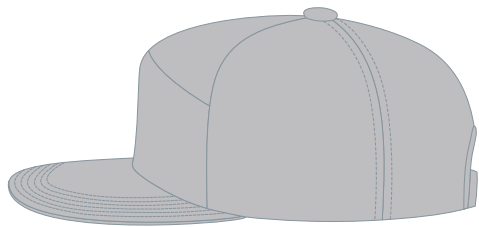
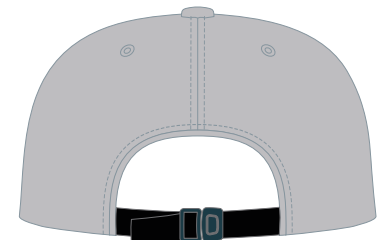
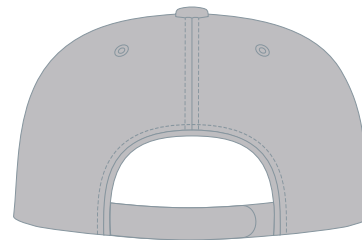
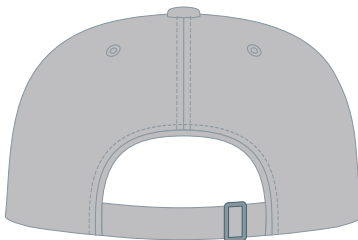
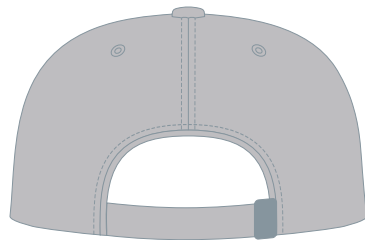
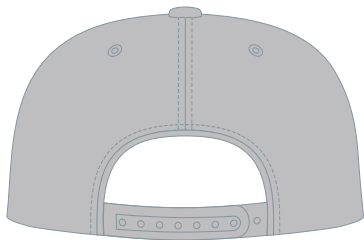
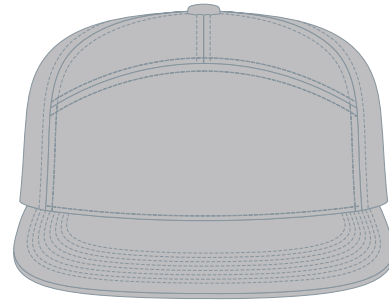

L - INTERNAL WOVEN LABEL



M - SEAM TAPE



O - BACKSTRAP WOVEN LABEL