

CUSTOMER NAME \_\_\_\_\_  
CONTACT \_\_\_\_\_  
DATE \_\_\_\_\_

**1 CAP STYLE: O55 - 5 PANEL PINCH SNAPBACK**

QUANTITY COLORWAY 1 : \_\_\_\_\_  
QUANTITY COLORWAY 2 : \_\_\_\_\_

QUICKTURN  
96 PC. MINIMUM  
48 PC. PER COLORWAY

STANDARD  
288 PC. MINIMUM  
72 PC. PER COLORWAY

**2 CAP DETAILS:**

COLORWAY 1 : [CLICK HERE FOR AVAILABLE COLOR SWATCHES](#)

COLORWAY 2 :

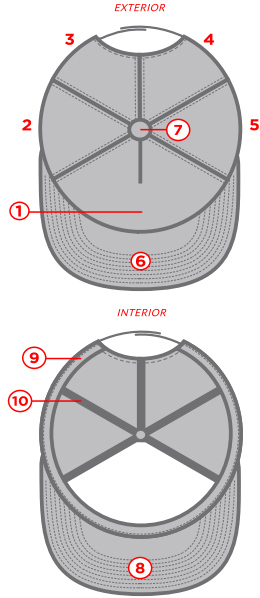

#	COLOR	FABRIC / MATERIAL	STITCH COLOR
1.	_____	_____	_____
2.	_____	_____	_____
3.	_____	_____	_____
4.	_____	_____	_____
5.	_____	_____	_____
6.	_____	_____	_____
7.	_____	_____	_____
8.	_____	_____	_____
9.	_____	_____	_____
10.	_____	_____	_____

#	COLOR	FABRIC / MATERIAL	STITCH COLOR
1.	_____	_____	_____
2.	_____	_____	_____
3.	_____	_____	_____
4.	_____	_____	_____
5.	_____	_____	_____
6.	_____	_____	_____
7.	_____	_____	_____
8.	_____	_____	_____
9.	_____	_____	_____
10.	_____	_____	_____

SUBLIMATION / SCREEN PRINT FILE NAME(S) : \_\_\_\_\_  
\_\_\_\_\_

ADDITIONAL NOTES

**3 VISOR**

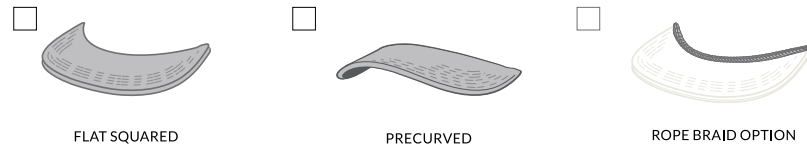

COLORWAY 1 / COLORWAY 2  
COLOR : \_\_\_\_\_ / \_\_\_\_\_

ADDITIONAL NOTES

**4 CLOSURE**

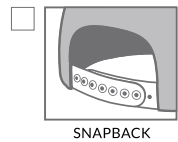

COLORWAY 1 / COLORWAY 2  
COLOR : \_\_\_\_\_ / \_\_\_\_\_

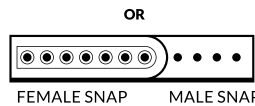

FEMALE SNAP COLOR: \_\_\_\_\_ / \_\_\_\_\_  
MALE SNAP COLOR: \_\_\_\_\_ / \_\_\_\_\_

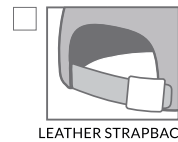

COLORWAY 1 / COLORWAY 2  
LEATHER COLOR

BLACK  LIGHT BROWN  DARK BROWN  WHITE

METAL CLASP COLOR

GOLD  SILVER  BRONZE  GUNMETAL BLACK

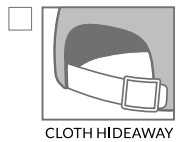

COLORWAY 1 / COLORWAY 2  
METAL CLASP COLOR

GOLD  SILVER  BRONZE  GUNMETAL BLACK

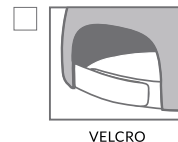

COLORWAY 1 / COLORWAY 2  
COLOR : \_\_\_\_\_ / \_\_\_\_\_

OR

LEFT COLOR: \_\_\_\_\_ / \_\_\_\_\_  
RIGHT COLOR: \_\_\_\_\_ / \_\_\_\_\_

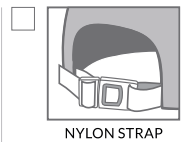

**5 DECORATION DESIGN MAP :**

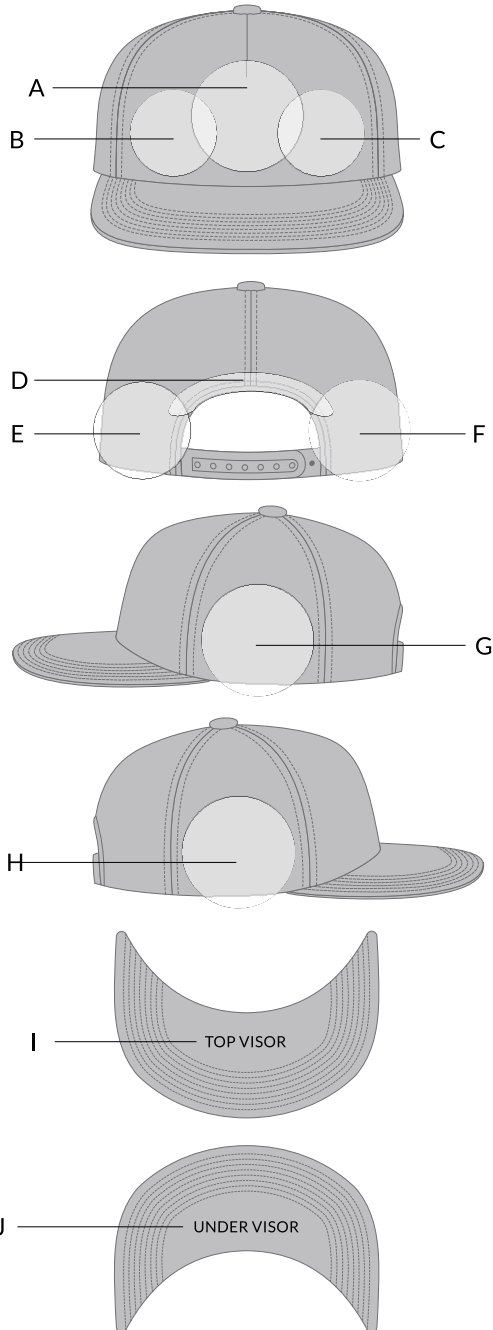

**DECORATION 1**

LOCATION (LETTER) \_\_\_\_\_

FILE NAME (ATTACH WEEMAIL) \_\_\_\_\_

SIZE (W x H) \_\_\_\_\_

COLOR(S) **COLORWAY 1 :** \_\_\_\_\_  
**COLORWAY 2 :** \_\_\_\_\_

- |   |   |
|---|---|
| <input type="checkbox"/> EMBROIDERY     | <input type="checkbox"/> WOVEN LABEL            |
| <input type="checkbox"/> 3D EMBROIDERY  | <input type="checkbox"/> WOVEN PATCH            |
| <input type="checkbox"/> FELT APPLIQUE  | <input type="checkbox"/> DEBOSSED LEATHER PATCH |
| <input type="checkbox"/> SCREEN PRINT   | <input type="checkbox"/> EMBROIDERED PATCH      |
| <input type="checkbox"/> TWILL APPLIQUE | <input type="checkbox"/> PRINTED PATCH          |

**NOTES**

**DECORATION 2**

LOCATION (LETTER) \_\_\_\_\_

FILE NAME (ATTACH WEEMAIL) \_\_\_\_\_

SIZE (W x H) \_\_\_\_\_

COLOR(S) **COLORWAY 1 :** \_\_\_\_\_  
**COLORWAY 2 :** \_\_\_\_\_

- |   |   |
|---|---|
| <input type="checkbox"/> EMBROIDERY     | <input type="checkbox"/> WOVEN LABEL            |
| <input type="checkbox"/> 3D EMBROIDERY  | <input type="checkbox"/> WOVEN PATCH            |
| <input type="checkbox"/> FELT APPLIQUE  | <input type="checkbox"/> DEBOSSED LEATHER PATCH |
| <input type="checkbox"/> SCREEN PRINT   | <input type="checkbox"/> EMBROIDERED PATCH      |
| <input type="checkbox"/> TWILL APPLIQUE | <input type="checkbox"/> PRINTED PATCH          |

**NOTES**

**DECORATION 3**

LOCATION (LETTER) \_\_\_\_\_

FILE NAME (ATTACH WEEMAIL) \_\_\_\_\_

SIZE (W x H) \_\_\_\_\_

COLOR(S) **COLORWAY 1 :** \_\_\_\_\_  
**COLORWAY 2 :** \_\_\_\_\_

- |   |   |
|---|---|
| <input type="checkbox"/> EMBROIDERY     | <input type="checkbox"/> WOVEN LABEL            |
| <input type="checkbox"/> 3D EMBROIDERY  | <input type="checkbox"/> WOVEN PATCH            |
| <input type="checkbox"/> FELT APPLIQUE  | <input type="checkbox"/> DEBOSSED LEATHER PATCH |
| <input type="checkbox"/> SCREEN PRINT   | <input type="checkbox"/> EMBROIDERED PATCH      |
| <input type="checkbox"/> TWILL APPLIQUE | <input type="checkbox"/> PRINTED PATCH          |

**NOTES**

**DECORATION 4**

LOCATION (LETTER) \_\_\_\_\_

FILE NAME (ATTACH WEEMAIL) \_\_\_\_\_

SIZE (W x H) \_\_\_\_\_

COLOR(S) **COLORWAY 1 :** \_\_\_\_\_  
**COLORWAY 2 :** \_\_\_\_\_

- |   |   |
|---|---|
| <input type="checkbox"/> EMBROIDERY     | <input type="checkbox"/> WOVEN LABEL            |
| <input type="checkbox"/> 3D EMBROIDERY  | <input type="checkbox"/> WOVEN PATCH            |
| <input type="checkbox"/> FELT APPLIQUE  | <input type="checkbox"/> DEBOSSED LEATHER PATCH |
| <input type="checkbox"/> SCREEN PRINT   | <input type="checkbox"/> EMBROIDERED PATCH      |
| <input type="checkbox"/> TWILL APPLIQUE | <input type="checkbox"/> PRINTED PATCH          |

**NOTES**



6 INTERNAL DECORATION + LABELING

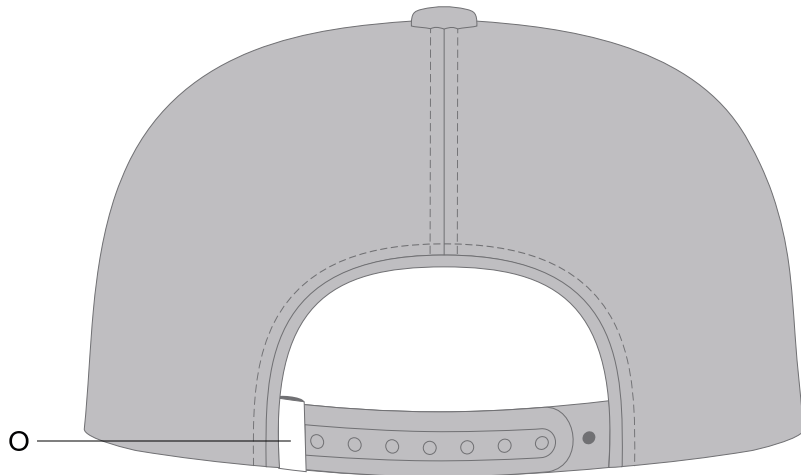
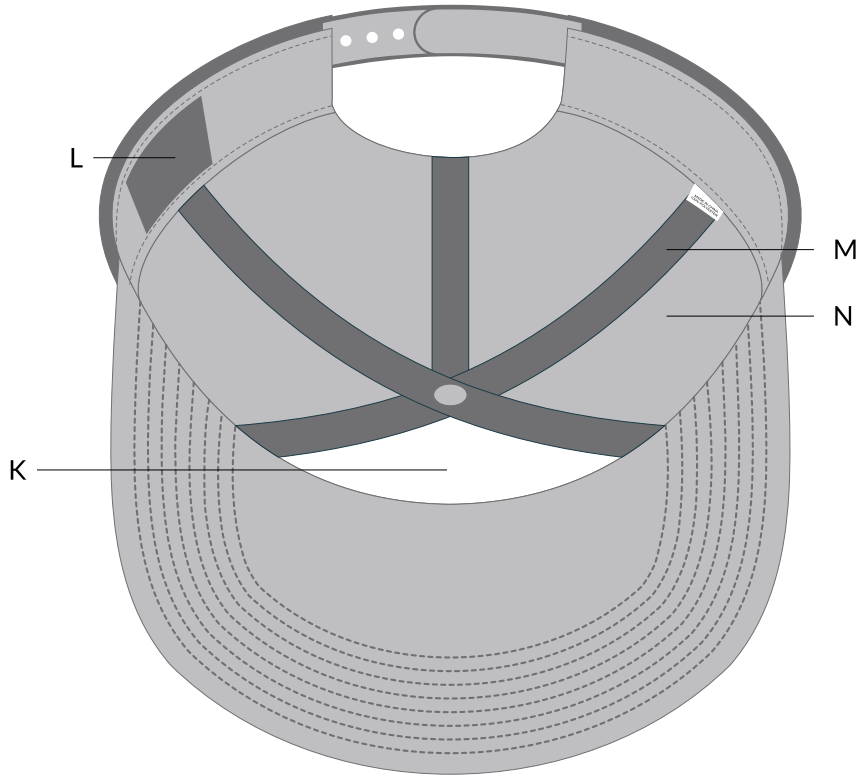

K - CROWN STRUCTURE

- BUCKRAM     NO STRUCTURE     LIGHT BUCKRAM

L - INTERNAL WOVEN LABEL



**PLEASE NOTE:** - MAX HEIGHT IS 25mm / .98"  
- MAX WIDTH IS 70mm / 2.75"  
- LABEL CAN BE PLACED ANYWHERE ON SWEATBAND

LABEL COLOR: \_\_\_\_\_

FILE NAME: \_\_\_\_\_  
(ATTACH W/EMAIL)

SIZE (W x H): \_\_\_\_\_

NOTES: \_\_\_\_\_

M - SEAM TAPE

**PLEASE NOTE:** - SEAM TAPE IS 13mm TALL / .5" TALL  
- HEIGHT BETWEEN STITCHING IS -7mm / -.27" TALL



SEAM TAPE COLOR: \_\_\_\_\_

FILE NAME: \_\_\_\_\_  
(ATTACH W/EMAIL)

N - INNER LINING

- NONE     CVC TWILL     TRICOT     SATIN

INNER LINING COLOR: \_\_\_\_\_

**SCREEN PRINT**     YES     NO    FILE NAME: \_\_\_\_\_  
(ATTACH W/EMAIL)

O - BACKSTRAP WOVEN LABEL



**PLEASE NOTE:** - MAX HEIGHT IS 20mm / .98"  
- RECOMMENDED WIDTH IS 11mm - 15mm / .43"-.6"  
- LABEL CAN ONLY BE PLACED ON LEFT SIDE

LABEL COLOR: \_\_\_\_\_

FILE NAME: \_\_\_\_\_  
(ATTACH W/EMAIL)

SIZE (W x H): \_\_\_\_\_

ADDITIONAL NOTES / DETAILS FOR CAP

\_\_\_\_\_

\_\_\_\_\_

\_\_\_\_\_

CAP TEMPLATES

ART REQUIREMENTS:

- PLEASE CONVERT TEXT TO OUTLINE
- PLEASE EXPAND ALL STROKES
- APPROPRIATE ART FILE TYPES ARE: AI, EPS, PDF

THIS PAGE IS OPTIONAL

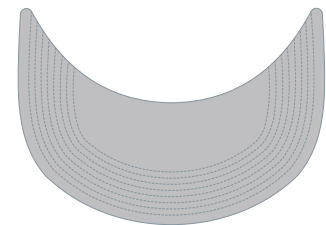
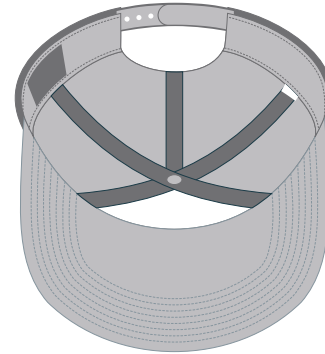
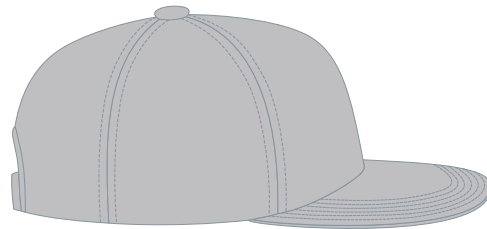
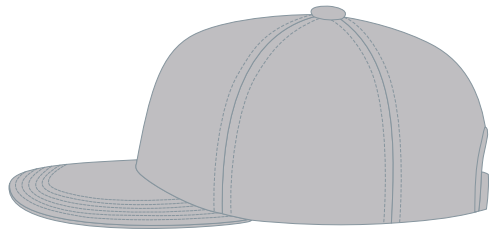
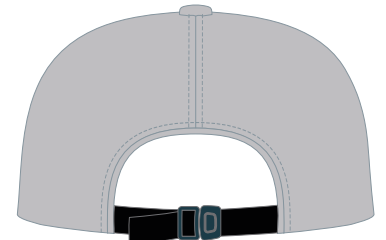
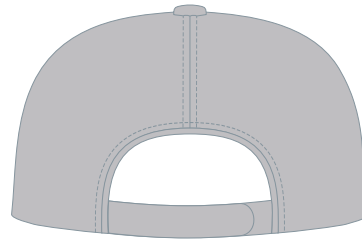
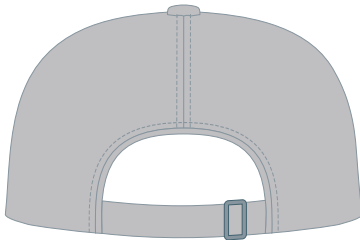
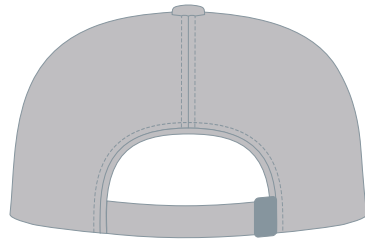
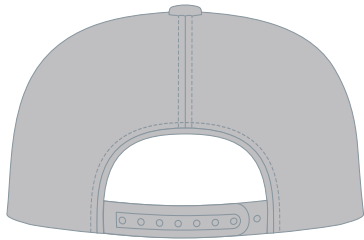
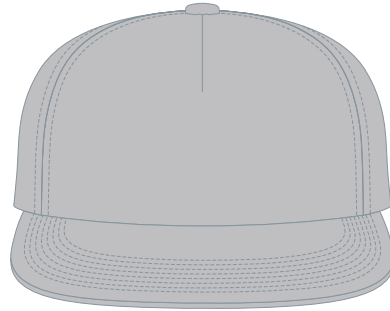

L - INTERNAL WOVEN LABEL



M - SEAM TAPE



O - BACKSTRAP WOVEN LABEL