

CUSTOMER NAME _____
CONTACT _____
DATE _____

1 CAP STYLE: O54 - FOAM FRONT TRUCKER

QUANTITY COLORWAY 1 : _____
QUANTITY COLORWAY 2 : _____

QUICKTURN
96 PC. MINIMUM
48 PC. PER COLORWAY

STANDARD
288 PC. MINIMUM
72 PC. PER COLORWAY

2 CAP DETAILS:

COLORWAY 1 : [CLICK HERE FOR AVAILABLE COLOR SWATCHES](#)

COLORWAY 2 :

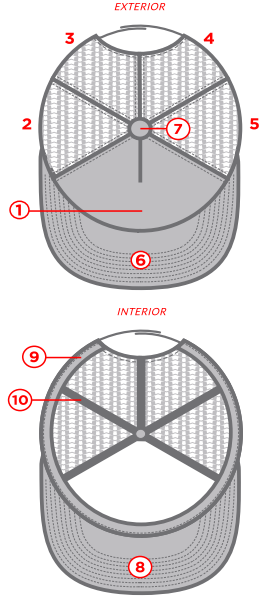

#	COLOR	FABRIC / MATERIAL	STITCH COLOR
1.	_____	_____	_____
2.	_____	_____	_____
3.	_____	_____	_____
4.	_____	_____	_____
5.	_____	_____	_____
6.	_____	_____	_____
7.	_____	_____	_____
8.	_____	_____	_____
9.	_____	_____	_____
10.	_____	_____	_____

#	COLOR	FABRIC / MATERIAL	STITCH COLOR
1.	_____	_____	_____
2.	_____	_____	_____
3.	_____	_____	_____
4.	_____	_____	_____
5.	_____	_____	_____
6.	_____	_____	_____
7.	_____	_____	_____
8.	_____	_____	_____
9.	_____	_____	_____
10.	_____	_____	_____

SUBLIMATION / SCREEN PRINT FILE NAME(S) : _____

ADDITIONAL NOTES

3 VISOR

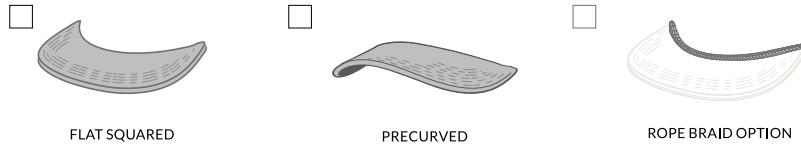

COLORWAY 1 / COLORWAY 2
COLOR : _____ / _____

ADDITIONAL NOTES

4 CLOSURE

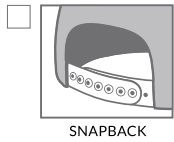

COLORWAY 1 / COLORWAY 2
COLOR : _____ / _____

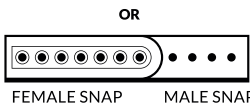

FEMALE SNAP COLOR: _____ / _____
MALE SNAP COLOR: _____ / _____

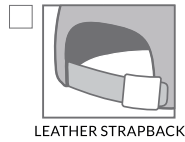

COLORWAY 1 / COLORWAY 2
LEATHER COLOR

BLACK LIGHT BROWN DARK BROWN WHITE

METAL CLASP COLOR

GOLD SILVER BRONZE GUNMETAL BLACK

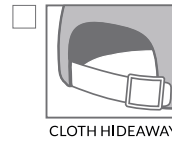

COLORWAY 1 / COLORWAY 2
METAL CLASP COLOR

GOLD SILVER BRONZE GUNMETAL BLACK

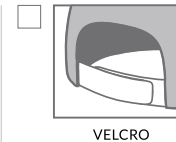

COLOR : _____ / _____
COLORWAY 1 / COLORWAY 2

OR

LEFT COLOR: _____ / _____

RIGHT COLOR: _____ / _____

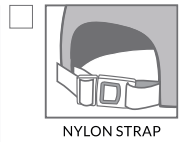

[BLACK ONLY]

5 DECORATION DESIGN MAP :

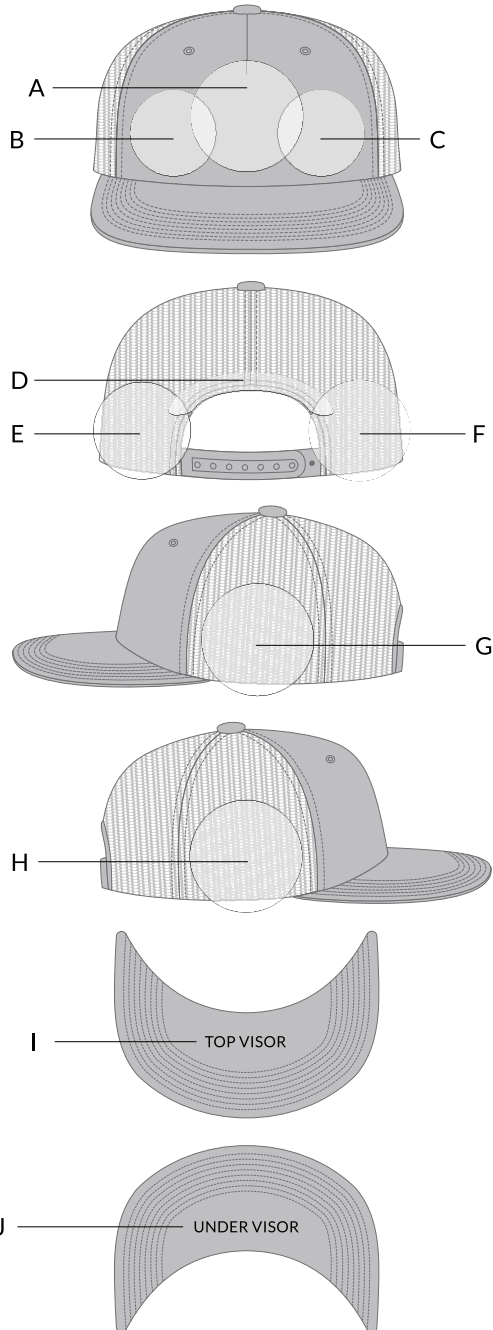

DECORATION 1

LOCATION _____
(LETTER)

FILE NAME _____
(ATTACH WEEMAIL)

SIZE (W x H) _____

COLOR(S) **COLORWAY 1 :** _____
COLORWAY 2 : _____

- | | |
|---|--|
| <input type="checkbox"/> EMBROIDERY | <input type="checkbox"/> WOVEN LABEL |
| <input type="checkbox"/> 3D EMBROIDERY | <input type="checkbox"/> WOVEN PATCH |
| <input type="checkbox"/> FELT APPLIQUE | <input type="checkbox"/> DEBOSSSED LEATHER PATCH |
| <input type="checkbox"/> SCREEN PRINT | <input type="checkbox"/> EMBROIDERED PATCH |
| <input type="checkbox"/> TWILL APPLIQUE | <input type="checkbox"/> PRINTED PATCH |

NOTES

DECORATION 2

LOCATION _____
(LETTER)

FILE NAME _____
(ATTACH WEEMAIL)

SIZE (W x H) _____

COLOR(S) **COLORWAY 1 :** _____
COLORWAY 2 : _____

- | | |
|---|--|
| <input type="checkbox"/> EMBROIDERY | <input type="checkbox"/> WOVEN LABEL |
| <input type="checkbox"/> 3D EMBROIDERY | <input type="checkbox"/> WOVEN PATCH |
| <input type="checkbox"/> FELT APPLIQUE | <input type="checkbox"/> DEBOSSSED LEATHER PATCH |
| <input type="checkbox"/> SCREEN PRINT | <input type="checkbox"/> EMBROIDERED PATCH |
| <input type="checkbox"/> TWILL APPLIQUE | <input type="checkbox"/> PRINTED PATCH |

NOTES

DECORATION 3

LOCATION _____
(LETTER)

FILE NAME _____
(ATTACH WEEMAIL)

SIZE (W x H) _____

COLOR(S) **COLORWAY 1 :** _____
COLORWAY 2 : _____

- | | |
|---|--|
| <input type="checkbox"/> EMBROIDERY | <input type="checkbox"/> WOVEN LABEL |
| <input type="checkbox"/> 3D EMBROIDERY | <input type="checkbox"/> WOVEN PATCH |
| <input type="checkbox"/> FELT APPLIQUE | <input type="checkbox"/> DEBOSSSED LEATHER PATCH |
| <input type="checkbox"/> SCREEN PRINT | <input type="checkbox"/> EMBROIDERED PATCH |
| <input type="checkbox"/> TWILL APPLIQUE | <input type="checkbox"/> PRINTED PATCH |

NOTES

DECORATION 4

LOCATION _____
(LETTER)

FILE NAME _____
(ATTACH WEEMAIL)

SIZE (W x H) _____

COLOR(S) **COLORWAY 1 :** _____
COLORWAY 2 : _____

- | | |
|---|--|
| <input type="checkbox"/> EMBROIDERY | <input type="checkbox"/> WOVEN LABEL |
| <input type="checkbox"/> 3D EMBROIDERY | <input type="checkbox"/> WOVEN PATCH |
| <input type="checkbox"/> FELT APPLIQUE | <input type="checkbox"/> DEBOSSSED LEATHER PATCH |
| <input type="checkbox"/> SCREEN PRINT | <input type="checkbox"/> EMBROIDERED PATCH |
| <input type="checkbox"/> TWILL APPLIQUE | <input type="checkbox"/> PRINTED PATCH |

NOTES



6 INTERNAL DECORATION + LABELING

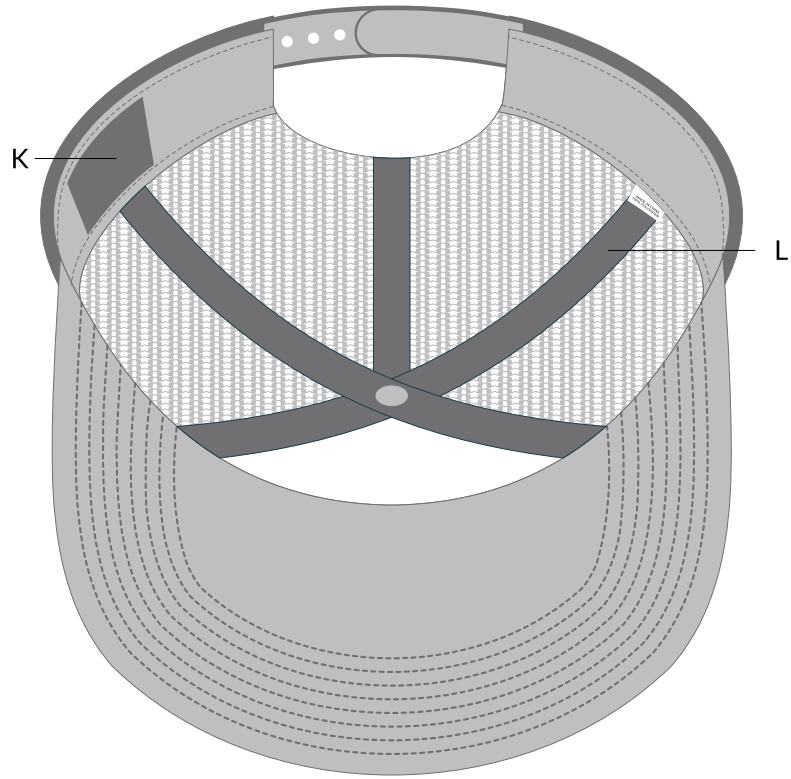

K - INTERNAL WOVEN LABEL



PLEASE NOTE: – MAX HEIGHT IS 25mm / .98"
– MAX WIDTH IS 70mm / 2.75"
– LABEL CAN BE PLACED ANYWHERE ON SWEATBAND

LABEL COLOR : _____

FILE NAME : _____
(ATTACH WEEMAIL)

SIZE (W x H) : _____

NOTES :

L - SEAM TAPE

PLEASE NOTE: – SEAM TAPE IS 13mm TALL / .5" TALL
– HEIGHT BETWEEN STITCHING IS -7mm / -.27" TALL



SEAM TAPE COLOR : _____

FILE NAME : _____
(ATTACH WEEMAIL)

M - BACKSTRAP WOVEN LABEL



PLEASE NOTE: – MAX HEIGHT IS 20mm / .98"
– RECOMMENDED WIDTH IS 11mm - 15mm / .43"- .6"
– LABEL CAN ONLY BE PLACED ON LEFT SIDE

LABEL COLOR : _____

FILE NAME : _____
(ATTACH WEEMAIL)

SIZE (W x H) : _____

ADDITIONAL NOTES / DETAILS FOR CAP

Blank area for additional notes or details for the cap.

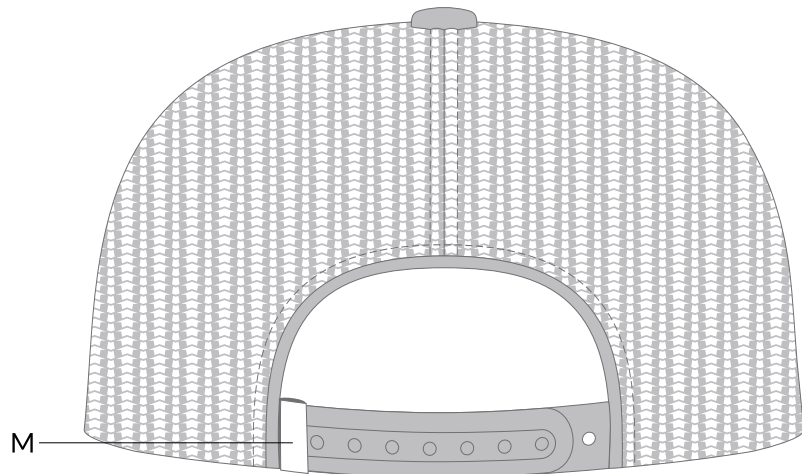

CAP TEMPLATES

ART REQUIREMENTS:

- PLEASE CONVERT TEXT TO OUTLINE
- PLEASE EXPAND ALL STROKES
- APPROPRIATE ART FILE TYPES ARE : AI, EPS, PDF

THIS PAGE IS OPTIONAL

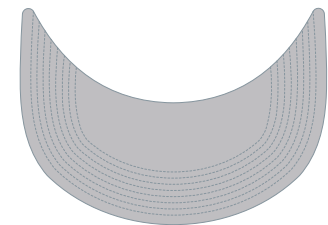
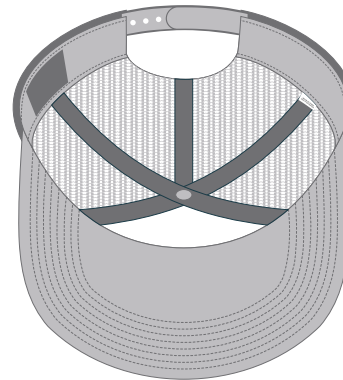
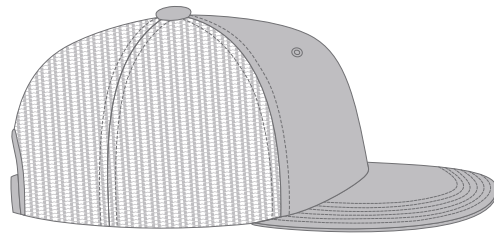
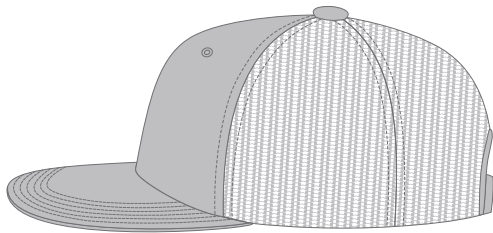
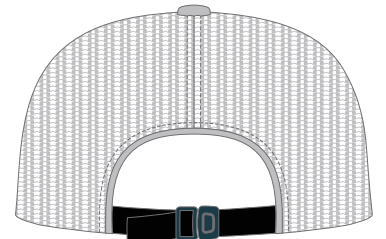
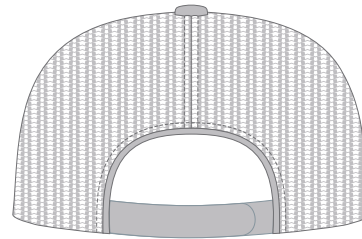
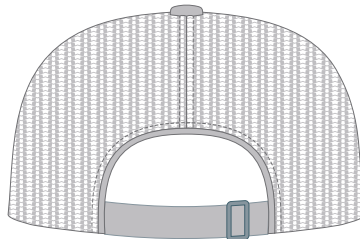
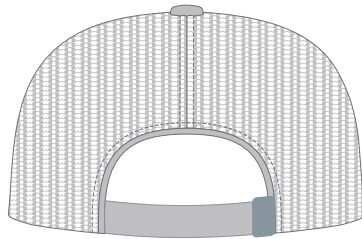
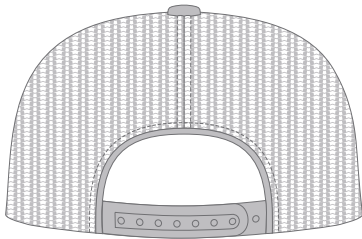
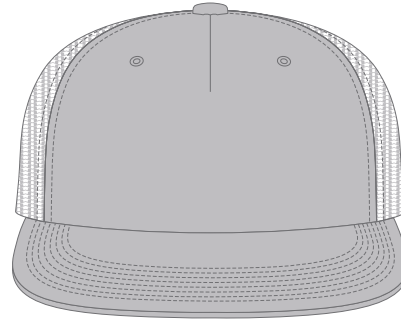

L - INTERNAL WOVEN LABEL



M - SEAM TAPE



O - BACKSTRAP WOVEN LABEL