

CUSTOMER NAME \_\_\_\_\_  
CONTACT \_\_\_\_\_  
DATE \_\_\_\_\_

**1 CAP STYLE: O19 - 5 PANEL**

QUANTITY COLORWAY 1 : \_\_\_\_\_  
QUANTITY COLORWAY 2 : \_\_\_\_\_

QUICKTURN  
96 PC. MINIMUM  
48 PC. PER COLORWAY

STANDARD  
288 PC. MINIMUM  
72 PC. PER COLORWAY

**2 CAP DETAILS:**

COLORWAY 1 : [CLICK HERE FOR AVAILABLE COLOR SWATCHES](#)

COLORWAY 2 :

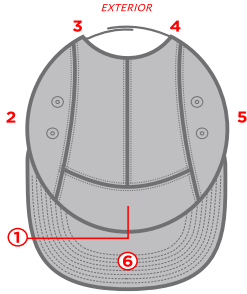

#	COLOR	FABRIC / MATERIAL	STITCH COLOR	EYELET COLOR
1.	_____	_____	_____	_____
2.	_____	_____	_____	_____
3.	_____	_____	_____	_____
4.	_____	_____	_____	_____
5.	_____	_____	_____	_____
6.	_____	_____	_____	_____
7.	_____	_____	_____	_____
8.	_____	_____	_____	_____
9.	_____	_____	_____	_____

#	COLOR	FABRIC / MATERIAL	STITCH COLOR	EYELET COLOR
1.	_____	_____	_____	_____
2.	_____	_____	_____	_____
3.	_____	_____	_____	_____
4.	_____	_____	_____	_____
5.	_____	_____	_____	_____
6.	_____	_____	_____	_____
7.	_____	_____	_____	_____
8.	_____	_____	_____	_____
9.	_____	_____	_____	_____

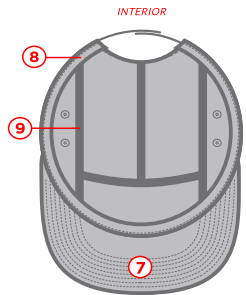

SUBLIMATION / SCREEN PRINT FILE NAME(S) : \_\_\_\_\_

METAL EYELETS  Y  N COLOR:  BLACK  
 SILVER  
 BRASS

ADDITIONAL NOTES

**3 VISOR**

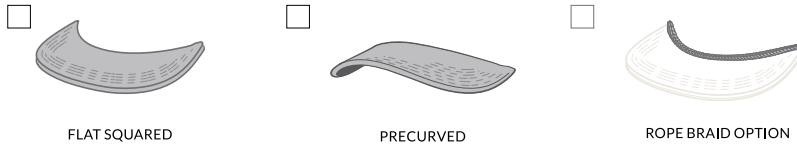

COLORWAY 1 / COLORWAY 2  
COLOR : \_\_\_\_\_

ADDITIONAL NOTES

**4 CLOSURE**

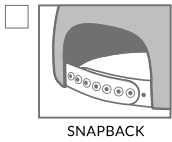

COLORWAY 1 / COLORWAY 2  
COLOR : \_\_\_\_\_

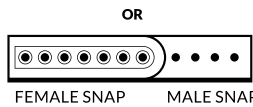

FEMALE SNAP COLOR: \_\_\_\_\_  
MALE SNAP COLOR: \_\_\_\_\_

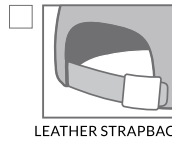

COLORWAY 1 / COLORWAY 2  
LEATHER COLOR  
 BLACK  
 LIGHT BROWN  
 DARK BROWN  
 WHITE

METAL CLASP COLOR  
 GOLD  
 SILVER  
 BRONZE  
 GUNMETAL BLACK

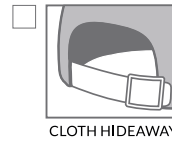

COLORWAY 1 / COLORWAY 2  
METAL CLASP COLOR  
 GOLD  
 SILVER  
 BRONZE  
 GUNMETAL BLACK

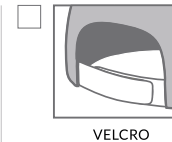

COLOR : \_\_\_\_\_  
COLORWAY 1 / COLORWAY 2

OR  
LEFT COLOR: \_\_\_\_\_

RIGHT COLOR: \_\_\_\_\_

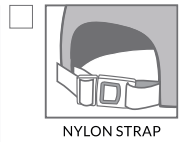

**5 DECORATION DESIGN MAP :**

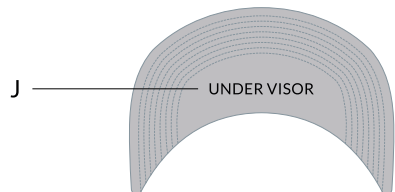
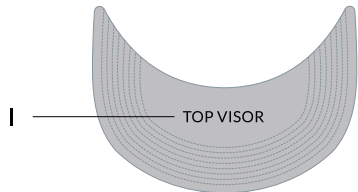
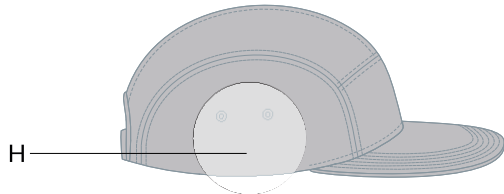
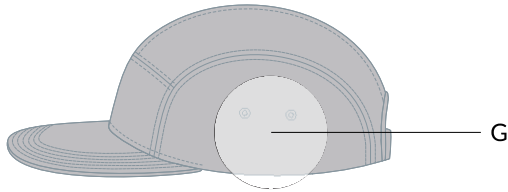
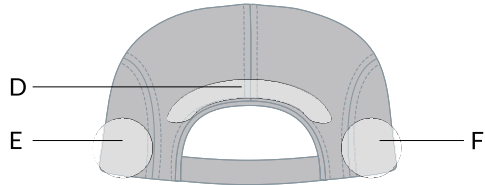
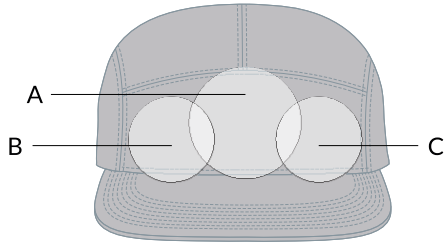

**DECORATION 1**

LOCATION \_\_\_\_\_  
(LETTER)

FILE NAME \_\_\_\_\_  
(ATTACH WEEMAIL)

SIZE (W x H) \_\_\_\_\_

COLOR(S) **COLORWAY 1 :** \_\_\_\_\_  
**COLORWAY 2 :** \_\_\_\_\_

- |   |  |
|---|--|
| <input type="checkbox"/> EMBROIDERY     | <input type="checkbox"/> WOVEN LABEL             |
| <input type="checkbox"/> 3D EMBROIDERY  | <input type="checkbox"/> WOVEN PATCH             |
| <input type="checkbox"/> FELT APPLIQUE  | <input type="checkbox"/> DEBOSSSED LEATHER PATCH |
| <input type="checkbox"/> SCREEN PRINT   | <input type="checkbox"/> EMBROIDERED PATCH       |
| <input type="checkbox"/> TWILL APPLIQUE | <input type="checkbox"/> PRINTED PATCH           |

**NOTES**

**DECORATION 2**

LOCATION \_\_\_\_\_  
(LETTER)

FILE NAME \_\_\_\_\_  
(ATTACH WEEMAIL)

SIZE (W x H) \_\_\_\_\_

COLOR(S) **COLORWAY 1 :** \_\_\_\_\_  
**COLORWAY 2 :** \_\_\_\_\_

- |   |  |
|---|--|
| <input type="checkbox"/> EMBROIDERY     | <input type="checkbox"/> WOVEN LABEL             |
| <input type="checkbox"/> 3D EMBROIDERY  | <input type="checkbox"/> WOVEN PATCH             |
| <input type="checkbox"/> FELT APPLIQUE  | <input type="checkbox"/> DEBOSSSED LEATHER PATCH |
| <input type="checkbox"/> SCREEN PRINT   | <input type="checkbox"/> EMBROIDERED PATCH       |
| <input type="checkbox"/> TWILL APPLIQUE | <input type="checkbox"/> PRINTED PATCH           |

**NOTES**

**DECORATION 3**

LOCATION \_\_\_\_\_  
(LETTER)

FILE NAME \_\_\_\_\_  
(ATTACH WEEMAIL)

SIZE (W x H) \_\_\_\_\_

COLOR(S) **COLORWAY 1 :** \_\_\_\_\_  
**COLORWAY 2 :** \_\_\_\_\_

- |   |  |
|---|--|
| <input type="checkbox"/> EMBROIDERY     | <input type="checkbox"/> WOVEN LABEL             |
| <input type="checkbox"/> 3D EMBROIDERY  | <input type="checkbox"/> WOVEN PATCH             |
| <input type="checkbox"/> FELT APPLIQUE  | <input type="checkbox"/> DEBOSSSED LEATHER PATCH |
| <input type="checkbox"/> SCREEN PRINT   | <input type="checkbox"/> EMBROIDERED PATCH       |
| <input type="checkbox"/> TWILL APPLIQUE | <input type="checkbox"/> PRINTED PATCH           |

**NOTES**

**DECORATION 4**

LOCATION \_\_\_\_\_  
(LETTER)

FILE NAME \_\_\_\_\_  
(ATTACH WEEMAIL)

SIZE (W x H) \_\_\_\_\_

COLOR(S) **COLORWAY 1 :** \_\_\_\_\_  
**COLORWAY 2 :** \_\_\_\_\_

- |   |  |
|---|--|
| <input type="checkbox"/> EMBROIDERY     | <input type="checkbox"/> WOVEN LABEL             |
| <input type="checkbox"/> 3D EMBROIDERY  | <input type="checkbox"/> WOVEN PATCH             |
| <input type="checkbox"/> FELT APPLIQUE  | <input type="checkbox"/> DEBOSSSED LEATHER PATCH |
| <input type="checkbox"/> SCREEN PRINT   | <input type="checkbox"/> EMBROIDERED PATCH       |
| <input type="checkbox"/> TWILL APPLIQUE | <input type="checkbox"/> PRINTED PATCH           |

**NOTES**



**6 INTERNAL DECORATION + LABELING**

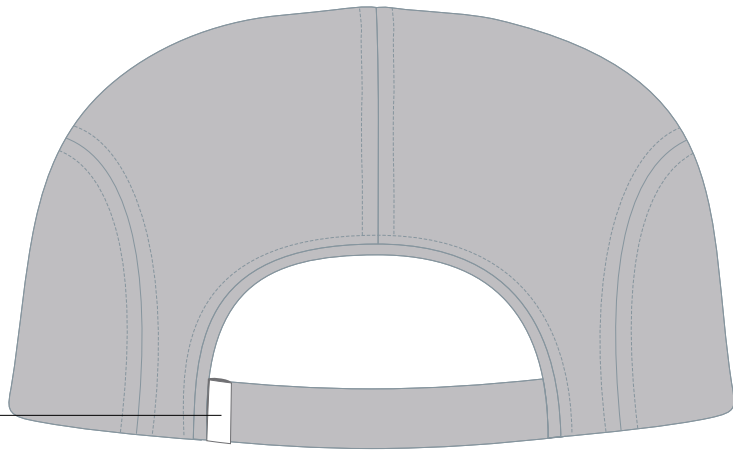
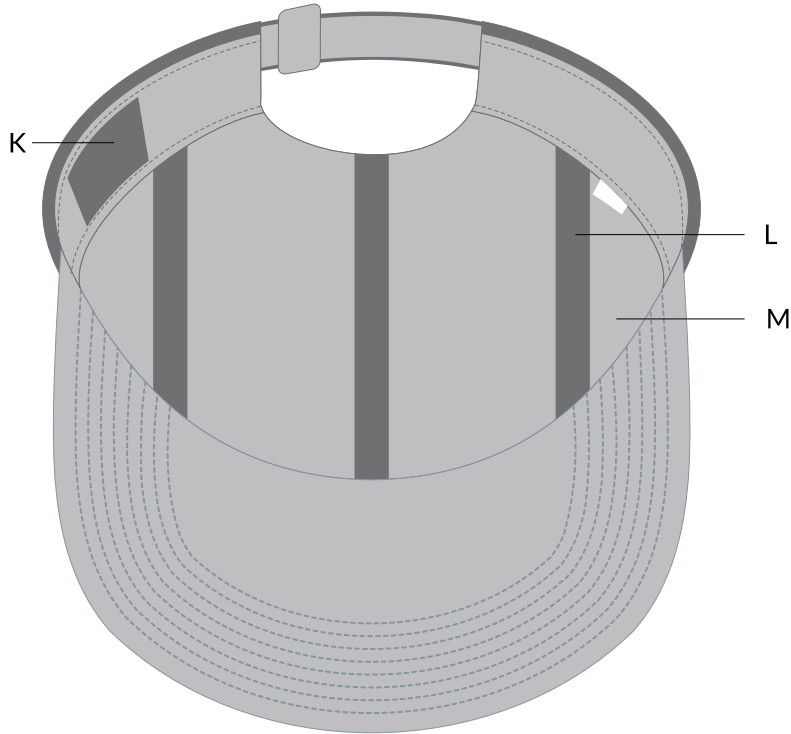

**K - INTERNAL WOVEN LABEL**



**PLEASE NOTE:** - MAX HEIGHT IS 25mm / .98"  
- MAX WIDTH IS 70mm / 2.75"  
- LABEL CAN BE PLACED ANYWHERE ON SWEATBAND

LABEL COLOR : \_\_\_\_\_

FILE NAME : \_\_\_\_\_  
(ATTACH WEMAIL)

SIZE (W x H) : \_\_\_\_\_

NOTES :

**L - SEAM TAPE**

**PLEASE NOTE:** - SEAM TAPE IS 13mm TALL / .5" TALL  
- HEIGHT BETWEEN STITCHING IS -7mm / -.27" TALL



SEAM TAPE COLOR : \_\_\_\_\_

FILE NAME : \_\_\_\_\_  
(ATTACH WEMAIL)

**M - INNER LINING**

NONE     CVC TWILL     TRICOT     SATIN

INNER LINING COLOR : \_\_\_\_\_

**SCREEN PRINT**     YES     NO    FILE NAME : \_\_\_\_\_  
(ATTACH WEMAIL)

**N - BACKSTRAP WOVEN LABEL**



**PLEASE NOTE:** - MAX HEIGHT IS 20mm / .98"  
- RECOMMENDED WIDTH IS 11mm - 15mm / .43"-.6"  
- LABEL CAN ONLY BE PLACED ON LEFT SIDE

LABEL COLOR : \_\_\_\_\_

FILE NAME : \_\_\_\_\_  
(ATTACH WEMAIL)

SIZE (W x H) : \_\_\_\_\_

**ADDITIONAL NOTES / DETAILS FOR CAP**

\_\_\_\_\_

\_\_\_\_\_

\_\_\_\_\_

\_\_\_\_\_

\_\_\_\_\_

CAP TEMPLATES

ART REQUIREMENTS:

- PLEASE CONVERT TEXT TO OUTLINE
- PLEASE EXPAND ALL STROKES
- APPROPRIATE ART FILE TYPES ARE : AI, EPS, PDF

THIS PAGE IS OPTIONAL

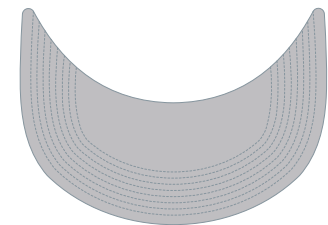
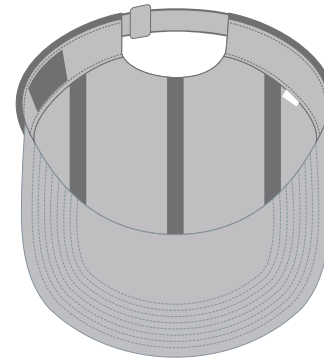
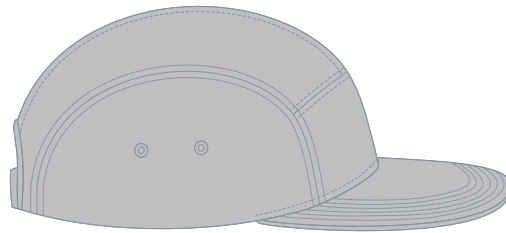
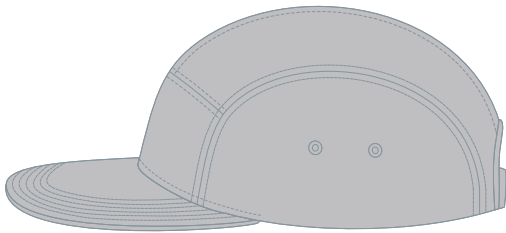
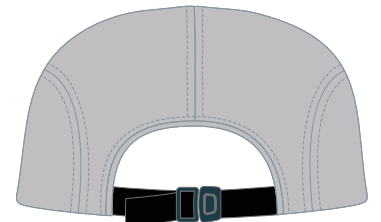
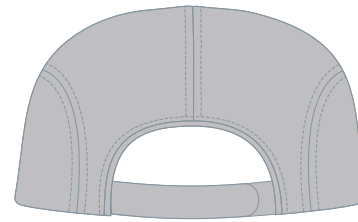
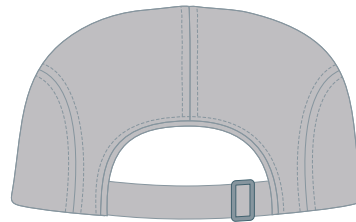
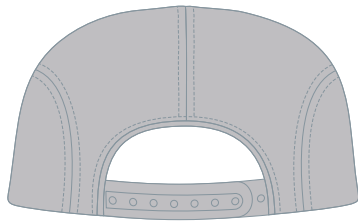
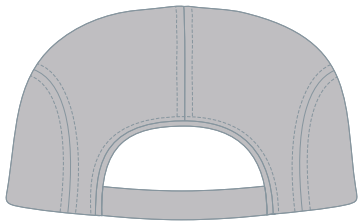
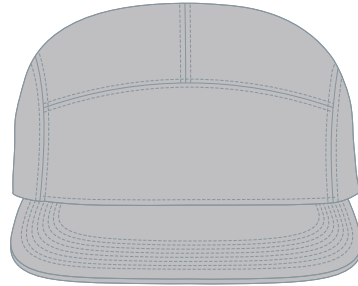

K - INTERNAL WOVEN LABEL



L - SEAM TAPE



N - BACKSTRAP WOVEN LABEL