

CUSTOMER NAME _____
CONTACT _____
DATE _____

1 CAP STYLE: O12 - TRUCKER SNAPBACK

QUANTITY COLORWAY 1 : _____
QUANTITY COLORWAY 2 : _____

QUICKTURN
96 PC. MINIMUM
48 PC. PER COLORWAY

STANDARD
288 PC. MINIMUM
72 PC. PER COLORWAY

2 CAP DETAILS:

COLORWAY 1 : [CLICK HERE FOR AVAILABLE COLOR SWATCHES](#)

COLORWAY 2 :

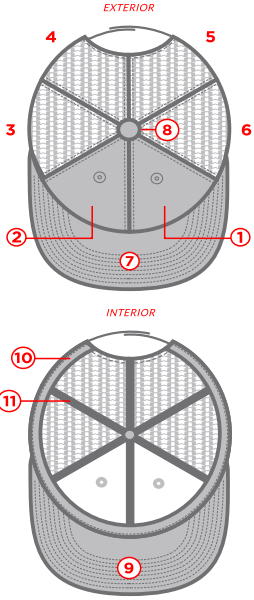

#	COLOR	FABRIC / MATERIAL	STITCH COLOR	EYELET COLOR
1.	_____	_____	_____	_____
2.	_____	_____	_____	_____
3.	_____	_____	_____	_____
4.	_____	_____	_____	_____
5.	_____	_____	_____	_____
6.	_____	_____	_____	_____
7.	_____	_____	_____	_____
8.	_____	_____	_____	_____
9.	_____	_____	_____	_____
10.	_____	_____	_____	_____
11.	_____	_____	_____	_____

#	COLOR	FABRIC / MATERIAL	STITCH COLOR	EYELET COLOR
1.	_____	_____	_____	_____
2.	_____	_____	_____	_____
3.	_____	_____	_____	_____
4.	_____	_____	_____	_____
5.	_____	_____	_____	_____
6.	_____	_____	_____	_____
7.	_____	_____	_____	_____
8.	_____	_____	_____	_____
9.	_____	_____	_____	_____
10.	_____	_____	_____	_____
11.	_____	_____	_____	_____

SUBLIMATION / SCREEN PRINT FILE NAME(S) : _____

METAL EYELETS Y N COLOR: BLACK
 SILVER
 BRASS

ADDITIONAL NOTES

3 VISOR

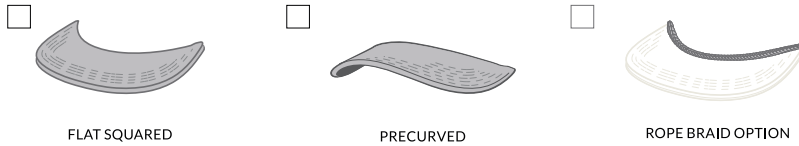

COLOR : _____ / _____

ADDITIONAL NOTES

4 CLOSURE

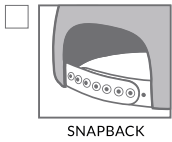

COLORWAY 1 COLORWAY 2

COLOR : _____ / _____

OR

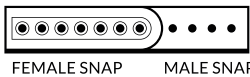

FEMALE SNAP COLOR: _____ / _____

MALE SNAP COLOR: _____ / _____

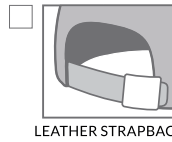

COLORWAY 1 COLORWAY 2

LEATHER COLOR

- BLACK
- LIGHT BROWN
- DARK BROWN
- WHITE

METAL CLASP COLOR

- GOLD
- SILVER
- BRONZE
- GUNMETAL BLACK

LEATHER COLOR

- BLACK
- LIGHT BROWN
- DARK BROWN
- WHITE

METAL CLASP COLOR

- GOLD
- SILVER
- BRONZE
- GUNMETAL BLACK

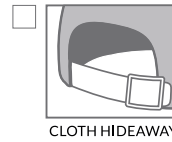

COLORWAY 1 COLORWAY 2

METAL CLASP COLOR

- GOLD
- SILVER
- BRONZE
- GUNMETAL BLACK

METAL CLASP COLOR

- GOLD
- SILVER
- BRONZE
- GUNMETAL BLACK

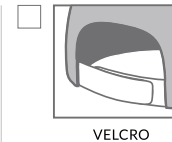

COLOR :

COLORWAY 1 COLORWAY 2

_____ / _____

OR

LEFT COLOR:

_____ / _____

RIGHT COLOR:

_____ / _____

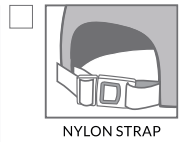

5 DECORATION DESIGN MAP :

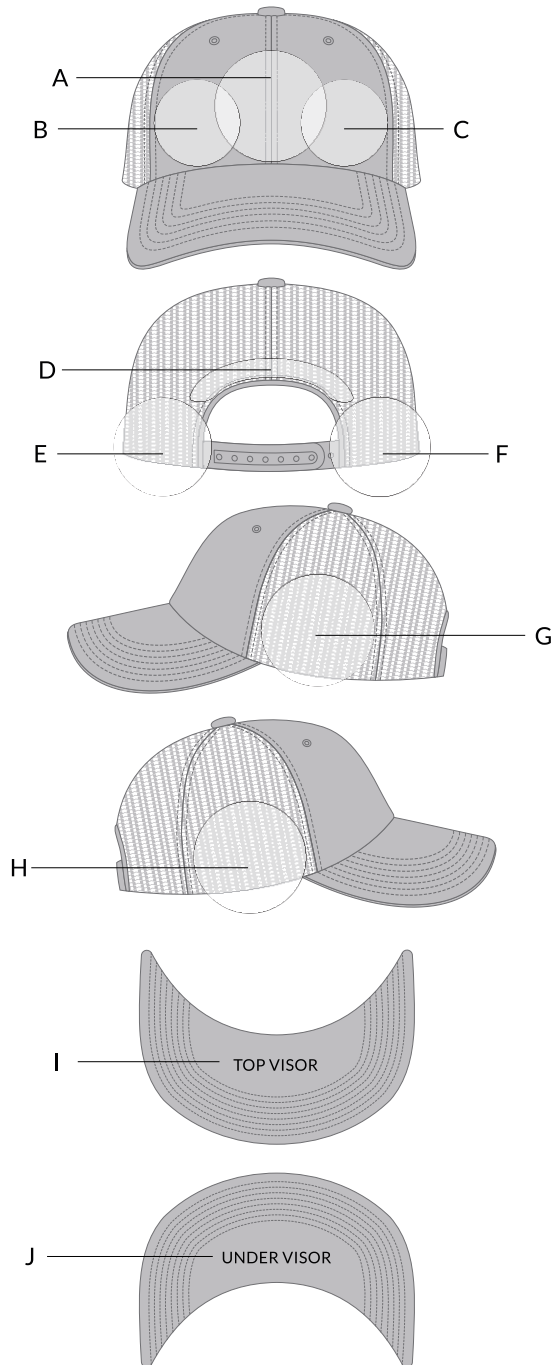

DECORATION 1

LOCATION (LETTER) _____

FILE NAME (ATTACH WEEMAIL) _____

SIZE (W x H) _____

COLOR(S) **COLORWAY 1 :** _____
COLORWAY 2 : _____

<input type="checkbox"/> EMBROIDERY	<input type="checkbox"/> WOVEN LABEL
<input type="checkbox"/> 3D EMBROIDERY	<input type="checkbox"/> WOVEN PATCH
<input type="checkbox"/> FELT APPLIQUE	<input type="checkbox"/> DEBOSSED LEATHER PATCH
<input type="checkbox"/> SCREEN PRINT	<input type="checkbox"/> EMBROIDERED PATCH
<input type="checkbox"/> TWILL APPLIQUE	<input type="checkbox"/> PRINTED PATCH

NOTES

DECORATION 2

LOCATION (LETTER) _____

FILE NAME (ATTACH WEEMAIL) _____

SIZE (W x H) _____

COLOR(S) **COLORWAY 1 :** _____
COLORWAY 2 : _____

<input type="checkbox"/> EMBROIDERY	<input type="checkbox"/> WOVEN LABEL
<input type="checkbox"/> 3D EMBROIDERY	<input type="checkbox"/> WOVEN PATCH
<input type="checkbox"/> FELT APPLIQUE	<input type="checkbox"/> DEBOSSED LEATHER PATCH
<input type="checkbox"/> SCREEN PRINT	<input type="checkbox"/> EMBROIDERED PATCH
<input type="checkbox"/> TWILL APPLIQUE	<input type="checkbox"/> PRINTED PATCH

NOTES

DECORATION 3

LOCATION (LETTER) _____

FILE NAME (ATTACH WEEMAIL) _____

SIZE (W x H) _____

COLOR(S) **COLORWAY 1 :** _____
COLORWAY 2 : _____

<input type="checkbox"/> EMBROIDERY	<input type="checkbox"/> WOVEN LABEL
<input type="checkbox"/> 3D EMBROIDERY	<input type="checkbox"/> WOVEN PATCH
<input type="checkbox"/> FELT APPLIQUE	<input type="checkbox"/> DEBOSSED LEATHER PATCH
<input type="checkbox"/> SCREEN PRINT	<input type="checkbox"/> EMBROIDERED PATCH
<input type="checkbox"/> TWILL APPLIQUE	<input type="checkbox"/> PRINTED PATCH

NOTES

DECORATION 4

LOCATION (LETTER) _____

FILE NAME (ATTACH WEEMAIL) _____

SIZE (W x H) _____

COLOR(S) **COLORWAY 1 :** _____
COLORWAY 2 : _____

<input type="checkbox"/> EMBROIDERY	<input type="checkbox"/> WOVEN LABEL
<input type="checkbox"/> 3D EMBROIDERY	<input type="checkbox"/> WOVEN PATCH
<input type="checkbox"/> FELT APPLIQUE	<input type="checkbox"/> DEBOSSED LEATHER PATCH
<input type="checkbox"/> SCREEN PRINT	<input type="checkbox"/> EMBROIDERED PATCH
<input type="checkbox"/> TWILL APPLIQUE	<input type="checkbox"/> PRINTED PATCH

NOTES



6 INTERNAL DECORATION + LABELING

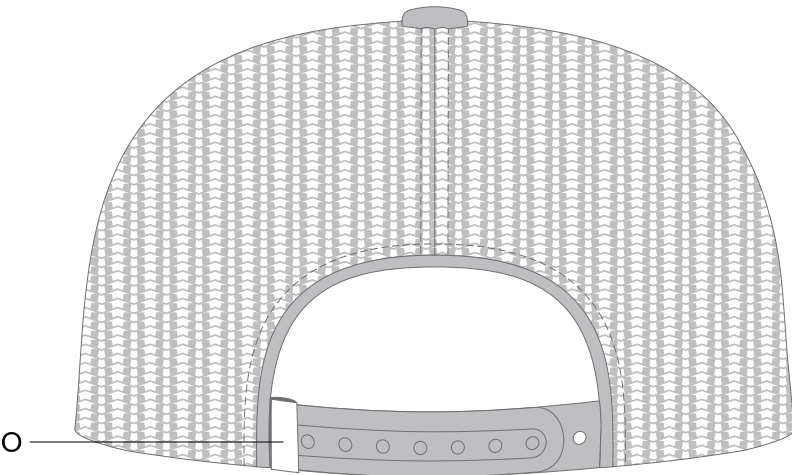
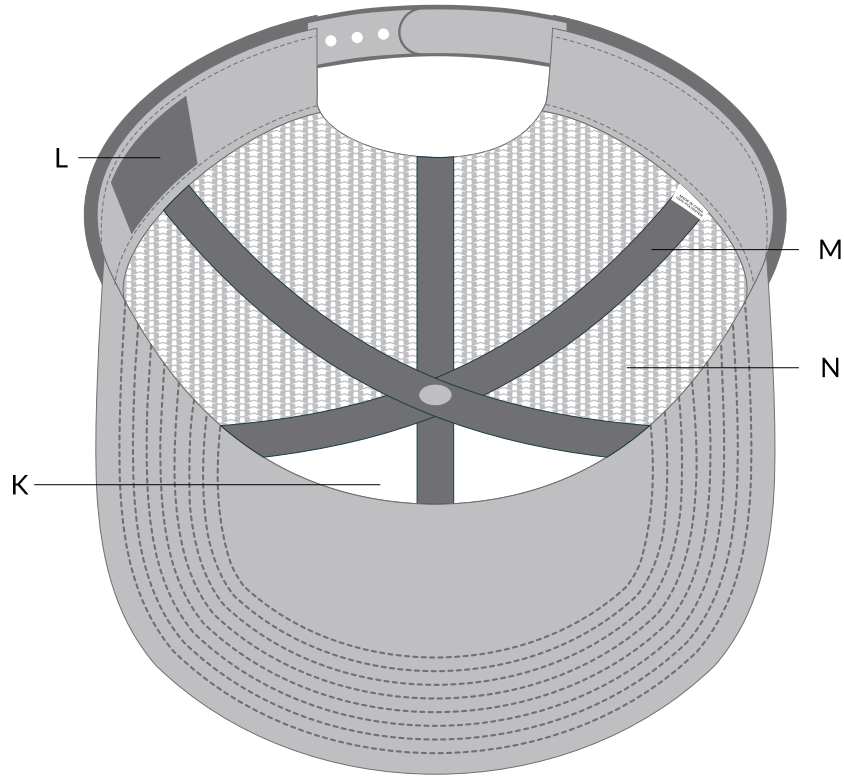

K - CROWN STRUCTURE

- BUCKRAM NO STRUCTURE LIGHT BUCKRAM

L - INTERNAL WOVEN LABEL



PLEASE NOTE: - MAX HEIGHT IS 25mm / .98"
- MAX WIDTH IS 70mm / 2.75"
- LABEL CAN BE PLACED ANYWHERE ON SWEATBAND

LABEL COLOR : _____

FILE NAME : _____
(ATTACH W/EMAIL)

SIZE (W x H) : _____

NOTES : _____

M - SEAM TAPE

PLEASE NOTE: - SEAM TAPE IS 13mm TALL / .5" TALL
- HEIGHT BETWEEN STITCHING IS -7mm / -.27" TALL



SEAM TAPE COLOR : _____

FILE NAME : _____
(ATTACH W/EMAIL)

N - INNER LINING

- NONE CVC TWILL TRICOT SATIN

INNER LINING COLOR : _____

SCREEN PRINT YES NO FILE NAME : _____
(ATTACH W/EMAIL)

O - BACKSTRAP WOVEN LABEL



PLEASE NOTE: - MAX HEIGHT IS 20mm / .98"
- RECOMMENDED WIDTH IS 11mm - 15mm / .43"-.6"
- LABEL CAN ONLY BE PLACED ON LEFT SIDE

LABEL COLOR : _____

FILE NAME : _____
(ATTACH W/EMAIL)

SIZE (W x H) : _____

ADDITIONAL NOTES / DETAILS FOR CAP

CAP TEMPLATES

ART REQUIREMENTS:

- PLEASE CONVERT TEXT TO OUTLINE
- PLEASE EXPAND ALL STROKES
- APPROPRIATE ART FILE TYPES ARE: AI, EPS, PDF

THIS PAGE IS OPTIONAL

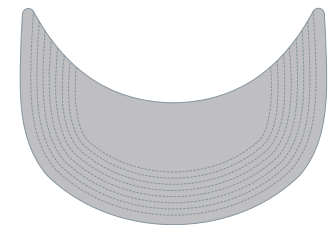
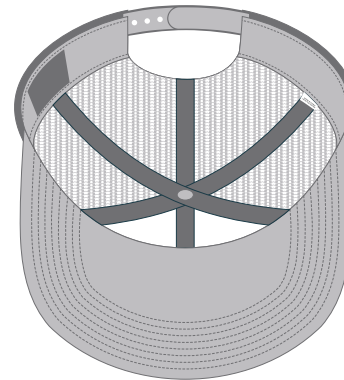
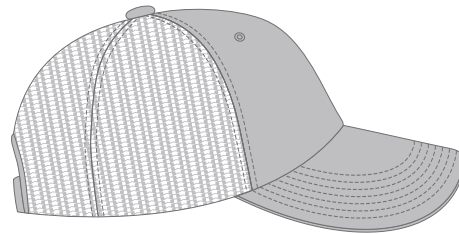
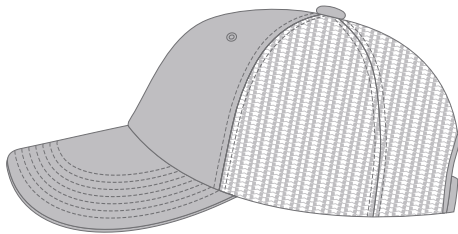
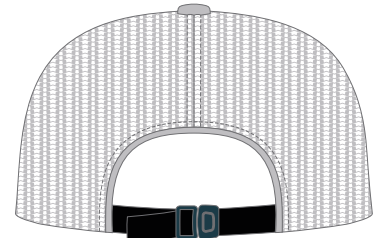
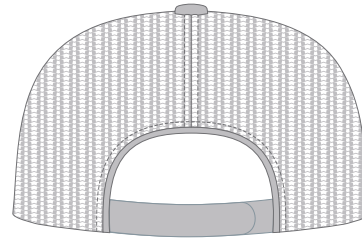
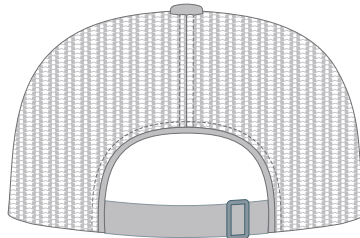
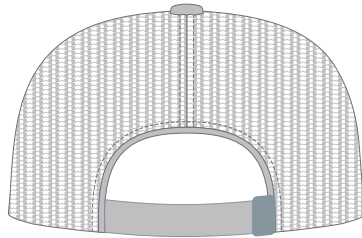
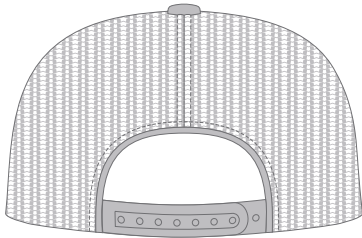

L - INTERNAL WOVEN LABEL



M - SEAM TAPE



O - BACKSTRAP WOVEN LABEL